

Burner Control Box

For 2-stage forced draught and combi oil/gas burners

Suitable flame detectors:

- Ionisation probe
- UV sensor
- Infra-red flicker detector

INTRODUCTION

The MMG burner control box is capable of controlling and monitoring forced draught and combi oil/gas burners of any nominal rating (tested and approved as per EN 298). The MMG 810.1 model 33 control boxes are also suitable for use in stationary warm air generators (Direct air heaters according to DIN 4794).

Different type and model designations identify the control boxes according to varying national standards, and to some extent, according to programme times.

TYPES AVAILABLE

MMG 810.1	Mod. 32	Art. Nr. 0640120
	Mod. 33	Art. Nr. 0640220
	Mod. 43	Art. Nr. 0642520
	Mod. 45	Art. Nr. 0642620
MMG 811.1	Mod. 33	Art. Nr. 0640520
	Mod. 63	Art. Nr. 0640420

CONSTRUCTIONAL FEATURES

The control box is enclosed in a protective, flame resistant, transparent, plug-in type plastic housing, and includes:

- Synchronous motor with reduction gearing driving cam switch
- Cam switch with informative, coloured programme indicator
- 12-way cam switch assembly controlling the programme sequence
- Electronic components on plug-in printed circuit

The following important indicators and operating controls are situated on the front of the control box:

- Reset button incorporating signal lamp for malfunction (lockout)
- Coloured programme indicator
- Central screw fastening



TECHNICAL DATA

Supply voltage	220 / 240 V (-15... +10%)
AC frequency variations	50 Hz (50 - 60 Hz) result in proportional timing deviations
Fuse rating	max. 10 A rapid, 6 A slow
Power consumption	10 VA
Max. current per output	
term. 3	2A, cos φ 0.2
term. 4, B	2A, cos φ 0.4
term. 5, 6, C	1A, cos φ 0.4
Total load	5A, cos φ 0.4
Amplifier sensitivity	1 μA
Min. current from UV tube or ionisation probe	5 μA
Flame detector cable	max. 20 m cable length
Air proving switch	1 terminal 4 A, 230 V
Reset delay	none
Flame detector	
- Ionisation probe	
- Infra-red flicker detector	IRD 1020.1 end-on
- UV tube type	UVZ 780 red markings installed radially or axially
Infra red flare detector	IRD 1020
Weight incl. base	350 g
Mounting attitude	any
Insulation standard	IP 44
Permissible ambient temp.	-20° C... +60° C
Classified acc. to EN 298	BTLXN

program timings (sec.)	MMG 810.1				811.1	
	32	33	43	45	33	63
Model						
Waiting time at start-up	tw	9	9	9	9	6
Max. reaction time for air proving switch	tlw	6	6	6	6	5
Pre-purge time	tv1	24	24	40	24	55
Pre-ignition time	tvz	3	3	3	3	3
T. ignition time	tz	6	6	6	8	5.5
Safety time	ts	2	3	3	5	3
Time delay						
term.6 / term.C	tv2	10	10	10	10	6

For external resetting, the remote reset device FR 870 (art. No. 70700) can be utilized. (Refer to doc. 750).

TECHNICAL FEATURES

1. Flame detection

The following types of flame detector can be employed:

- Ionisation electrode, where the mains supply provides a neutral earth connection. Suitable for gas burners (signal current from flame cannot be influenced by interference from ignition spark).
- UV sensor type UVZ 780 red, suitable for gas and combi burners.
- Infra-red flicker detector type IRD 1020.1 for all types of burner.

2. Burner Control

- The burner controls features a low-voltage protection. If the supply voltage drops below 160 V during operation, the burner switches-off. When the supply voltage raises above 180 V, the burner performs a restart independently.
- The MMG control boxes only operate when a load is connected to terminal 5. If the fuel valve is isolated during the pre-purge by way of an external switch contact, a resistor with a value of max. 22 k Ω /4 watts, must be connected between terminals 5 and 8.
- Functional check of the air proving switch before the start, and monitoring of the air pressure during pre-purge as well as during normal operation. In normal use, switch contacts with a rating of 4 A / 220 V are sufficient.
- On the MMG 810.1, switch contacts (e.g. valve end contact) can be wired between terminals 1 and 9. These contacts are checked for proper closure during the burner start phase. The connection between terminals 1 and 9 must be complete during the start phase.
- The MMG 810.1 control box monitors the ignition spark if the UVZ 780 (red) is used for flame detection, and terminals C and 9 are wired together.

3. Safety

The design/construction and programme sequence of the control boxes in the MMG series conform to the present applicable European standards and regulations.

4. Installation

At the base:

- 3 earth terminals with additional terminal for burner earthing
- 3 neutral terminals with internal permanent connection to neutral terminal 8
- 2 independent spare terminals (S1 and S2)
- extra terminals A, B and C are standard
- 2 slide-in plates and 2 easy knock out holes plus 2 knock out holes in the base bottom facilitate the base wiring

Please note

To assist trouble-free operation the main neutral connection terminal 8 in the wiring base must be fully tightened. The terminal screws are already in the undone position. To connect a wire to the terminal, the screw only needs to be fastened.

General:

- Can be mounted in any position, insulated as per IP 44 standard (unaffected by water spray). The control box and detector probes should however not be subjected to excessive vibration.
- The applicable installation regulations must be observed during installation.

COMMISSIONING AND MAINTENANCE

1. Important

- The wiring must be checked exactly when commissioning the installation. Incorrect wiring could damage the control box, putting the safety of the burner system at risk.
- The chosen fuse rating must not, on any account, be higher than the value given in the technical data. Failure to observe this instruction could, in the case of a short circuit, have serious consequences for the control box or burner system.
- For safety reasons, it must be ensured that the control box performs at least one normal shut-down during every 24 hour period.
- Switch off or disconnect the power before plugging in or unplugging the unit.
- Control boxes are safety devices and should not to be interfered with.

2. Functional Check

During commissioning and after an overhaul of the burner, the following checks have to be carried out:

- a) Starting test with closed manual valve and bridged gas monitor contact:
 - The device must go into a fault condition after the safety period has elapsed.
- b) Close the manual valve in operating position with the gas monitor contact bridged.
 - The device must go into a fault condition after a flame failure.
- c) Air pressure monitor contact interrupted:
 - Device goes into a fault condition.
- d) Bridge air pressure monitor contact before starting:
 - Device must not start.

3. Trouble Shooting

Burner does not go into operation, programme indication remains:

- Electrical connection defective.
- Thermostat or gas monitor "OFF".

Burner does not go into operation, programme indication rotates continuously:

- Air pressure monitor defective, respectively, not in starting position. (Working contact must be open).
- Connection term. 1 - term. 9 interrupted
- mains voltage < 180V

The automatic control switches to fault condition shortly after the start of the pre-purge time (line within the blue zone):

- Air pressure monitor contact does not close.
- No load on terminal 5.
- Flame signal.

Automatic control switches to fault condition during the pre-purging (blue zone):

- No flame formation (ignition missing, valve does not open, etc.)
- No flame signal or too weak flame signal (flame does not adhere, poor insulation of the flame detector, burner not properly connected to the earth conductor).

Automatic control switches to fault condition during the operating position (red, resp. green zone):

- Flame lift-off
- Air pressure monitor contact opens
- Flame signal too weak.

SCHEMATIC CONNECTION DIAGRAM AND PROCESS DIAGRAM MMG 810.1

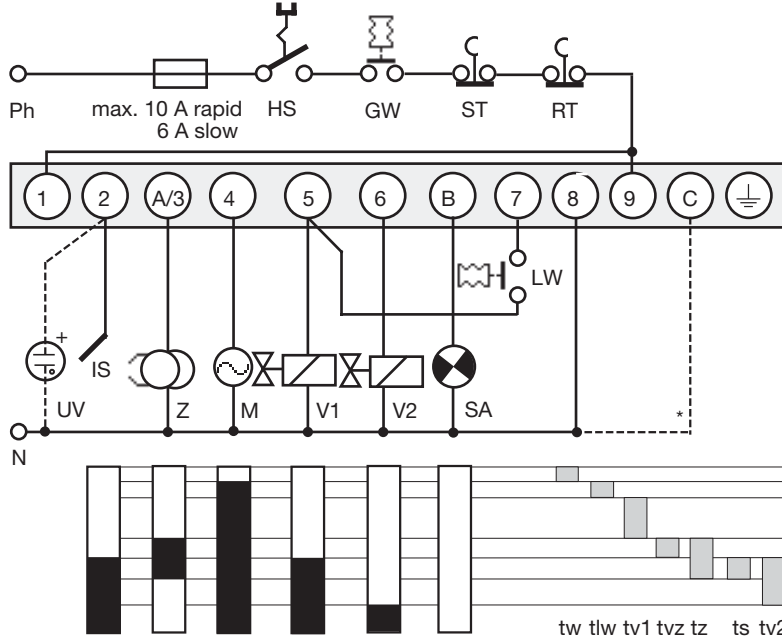

* for ign. spark detection only

- HS Mains switch
- GW Gas pressure switch
- ST Limit thermostat
- RT Control thermostat
- IS Ionisation probe
- UV UV sensor
- Z Ignition
- M Burner motor
- V1 Solenoid valve, 1st-stage
- V2 Solenoid valve, 2nd-stage
- LW Air pressure monitor
- SA External lock-out signal for spark detection only
- SV Safety valve

SCHEMATIC CONNECTION DIAGRAM AND PROCESS DIAGRAM MMG 811.1

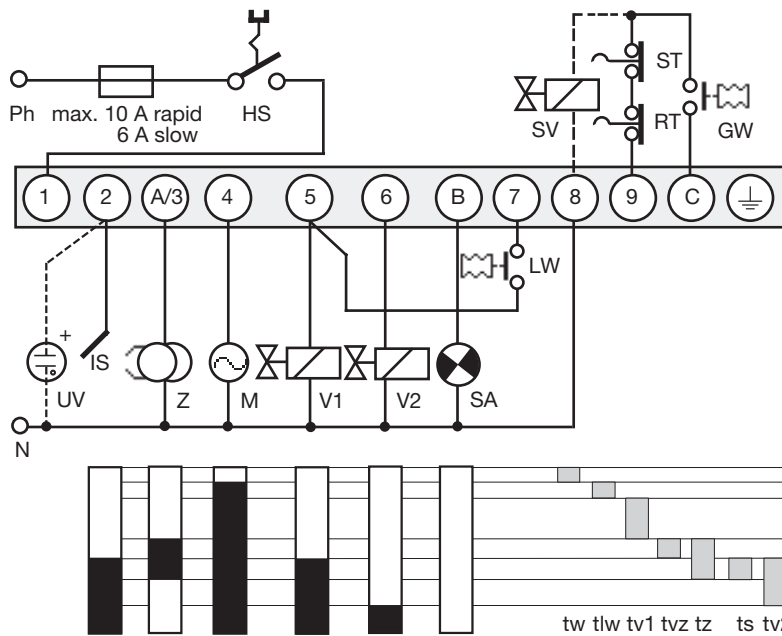

- tw Waiting time at start-up
- tlw Max. reaction time for air proving switch
- tv1 Pre-purge time
- tvz Pre-ignition time
- tz Total ignition time
- ts Safety time
- tv2 Time delay term.6 / term. C

IRD CONNECTION

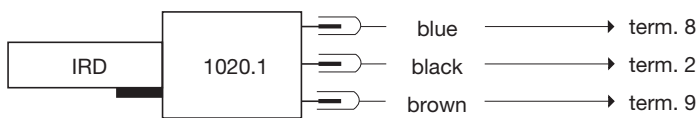

SCHEMATIC DIAGRAMMM MMG 810.1

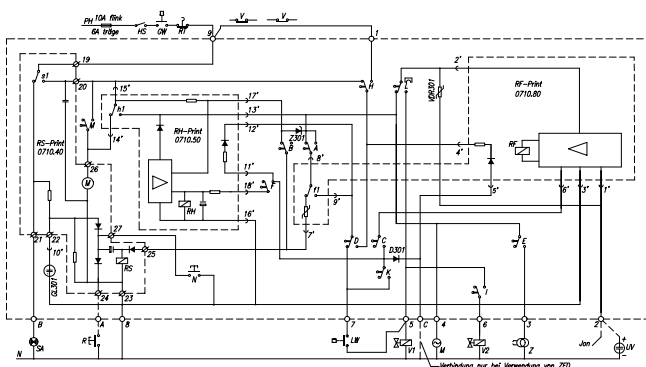

SCHEMATIC DIAGRAMMM MMG 811.1

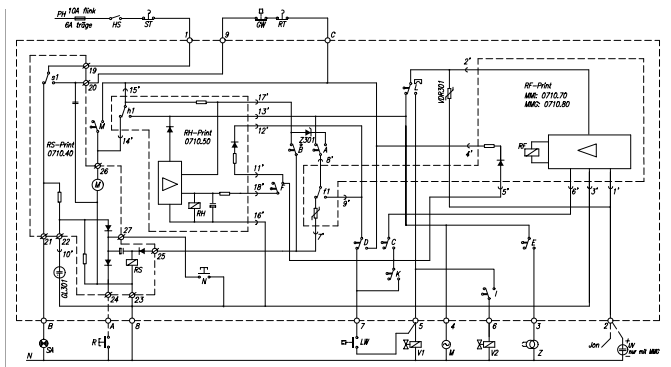

MMG AND SOCKET

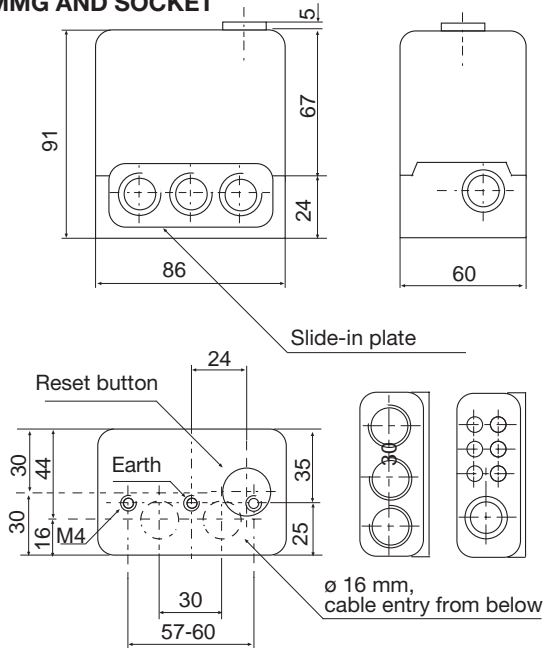

UVZ 780 AND HOLDER

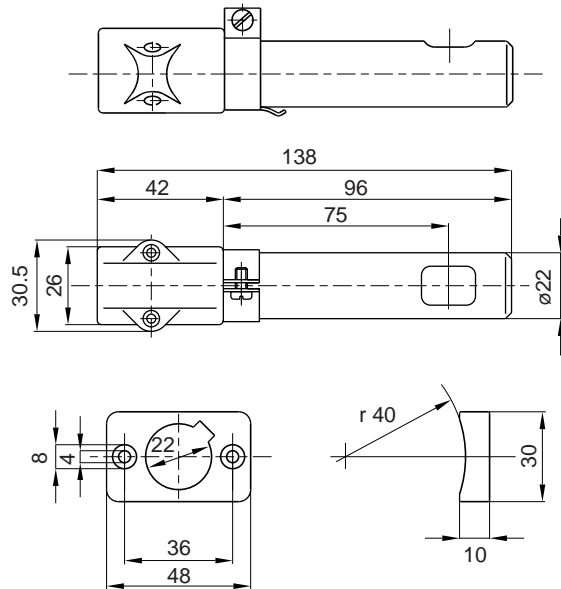

IRD 1020.1

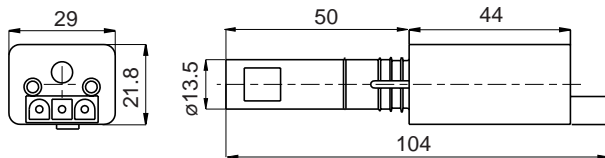

HOLDER M93

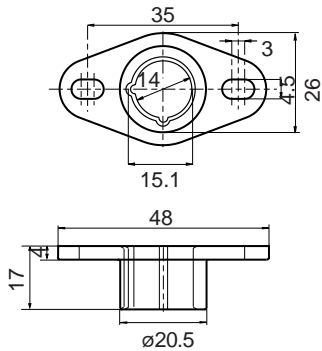

CHECKING THE FLAMESIGNAL

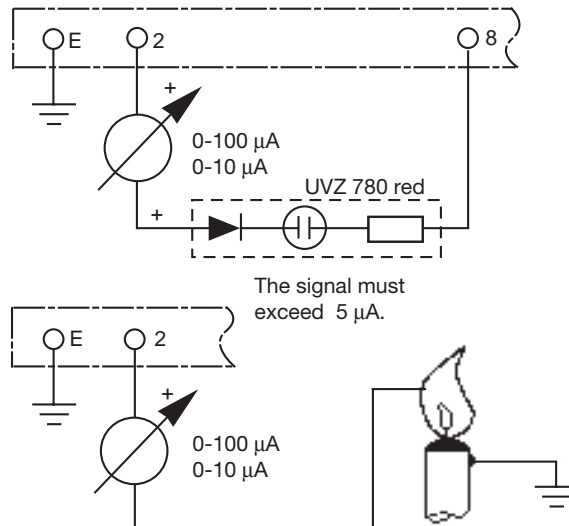

ORDERING INFORMATION

ITEM	DESIGNATION	ITEM NO.
Control box	Type MMG 810.1 mod. 33	0640220
or	Type MMG 811.1 mod. 33	0640520
Socket	Wiring base S98 12-pin	75310
Slide-in plate	Cable terminal plate	70502
or	PG-plate	70503
Flame detector	IRD 1020.1 end-on viewing	16552
Flame detector	UVZ 780 red	18813
IRD mounting flange	IRD Holder M93	59093
UVZ mounting flange	UVZ Holder	18807
Flame detector cable	3-wire, 0.6 m	7236001

The above ordering information refers to the standard version.
Special versions are also included in our product range.

Specifications subject to change without notice.

MMG810.1/811.1

satronic
A Honeywell Company

Satronic AG
Honeywell-Platz 1
Postfach 324
CH-8157 Dielsdorf